

SIDERMAT combination 630 to 1800 A

- ▶ Functions
- ▶ References
- Accessories
- Characteristics
- Dimensions

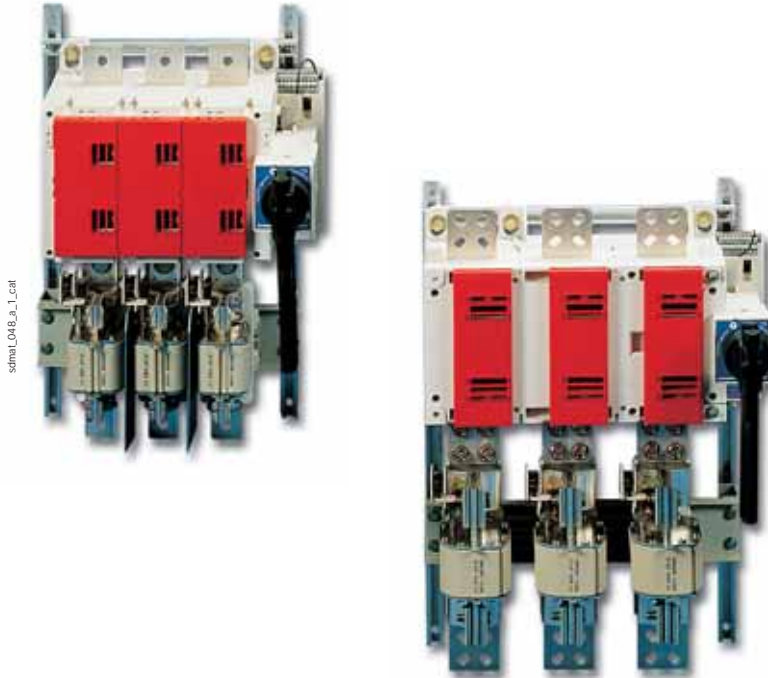

Functions

SIDERMAT combination are manually operated tri- or tetrapolar fuse disconnecting switches which can be triggered remotely.

They provide breaking and switch-off under load, safety isolation and protection against overcurrents for any low voltage electrical circuit.

They can automatically switch on a power circuit in combination with:

- fuse blown indication,
- thermal relay,
- differential relay,
- DIRIS (Ptm, CP, P...)
- other protective devices.

Conformity to standards

- IEC 60269-1
- IEC 60269-2
- IEC 60947-3
- NF EN 60269-1
- NF EN 60269-2
- EN 60947-3
- NF C 63211
- BS EN 60947-3
- NBN EN 60947-3
- DIN 43620
- VDE 0636-10
- VDE 0660 Part 107

General characteristics

- Remote control by tripping coils
- Fully visible breaking
- Double visible breaking
- Protection against overcurrents by fuse links (gG, aM) with high breaking capacity (100 kA eff.)
- Device supplied without fuses.

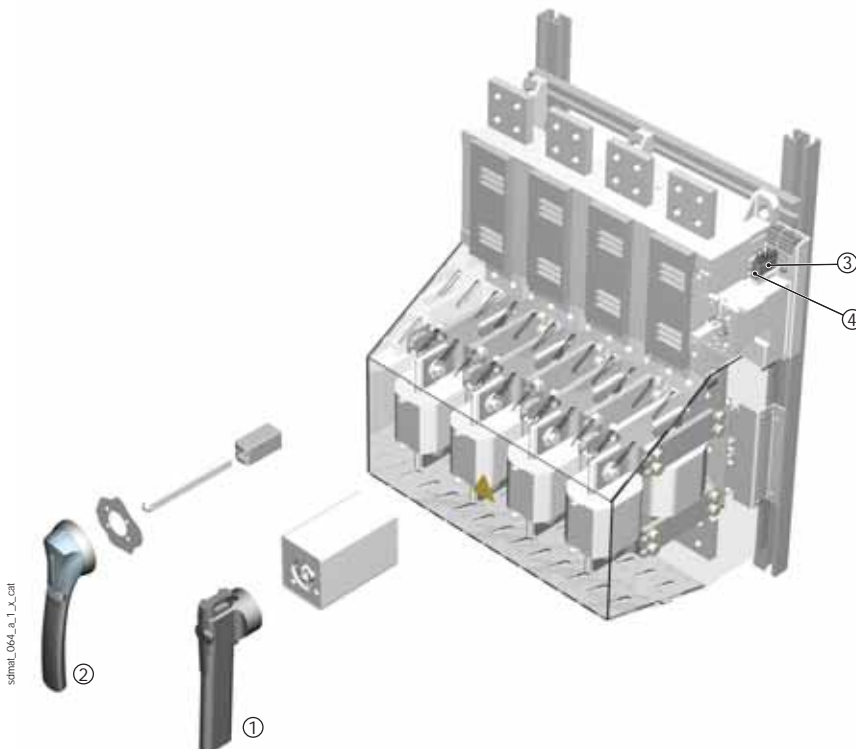

Overview (for further details, please see the installation instructions supplied with each device).

1. Direct front operation.
2. External front operation.
3. NO/NC position auxiliary contacts.
4. NO/NC auxiliary contacts linked to factory-mounted shunt trip coil.

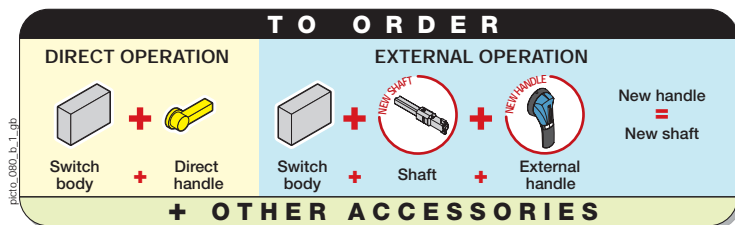

References

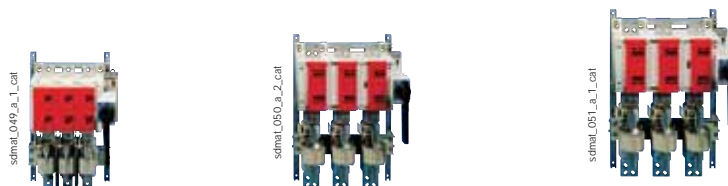

Switches Fuse size	630 A 3	800 A 4	1250 A 4	1600 A 2 x 4	1800 A 2 x 4
--------------------	------------	------------	-------------	-----------------	-----------------

SIDERMAT combination with a shunt trip coil 230 VAC - Front operation switch (switch body only)

No. of poles	References	References	References	References	References
3 pole	3520 3063	3520 3080	3520 3120	3520 3160	3520 3180
3 pole + switched neutral				3520 4160	3520 4180
4 pole	3520 6063	3520 6080	3520 6120	3520 6160	3520 6180

Accessories

Direct front operation handle

Black		3999 6203	3999 6203	3999 6203	3999 6203	3999 6203
Red		consult us	consult us	consult us	consult us	consult us

Door interlocked external front operation

Black	IP55		1431 3511	1431 3511	1431 3511	1431 3511	1431 3511
Red	IP55		1432 3511	1432 3511	1432 3511	1432 3511	1432 3511

Shaft extension for external operation (for other lengths, see "Accessories" pages)

200 mm		1401 1520	1401 1520			
320 mm		1401 1532	1401 1532	1401 1532	1401 1532	1401 1532

Auxiliary contacts

Position	1 st AC	NC / NO changeover	3999 0051	3999 0051	3999 0051	3999 0051	3999 0051
Position	2 nd AC	NC / NO changeover	3999 0052	3999 0052	3999 0052	3999 0052	3999 0052
Tripping	1 AC	NC / NO changeover	3999 0031	3999 0031	3999 0031	3999 0031	3999 0031

Fuse blown indication

1 st AC	NO / NC changeover	standard	standard	standard	standard	standard
--------------------	--------------------	----------	----------	----------	----------	----------

Terminal shrouds

3 pole	top	3998 3063				
4 pole	top	3998 4063				

Terminal screens

3 pole	top		2998 3120	2998 3120	2998 3120	2998 3180
4 pole	top		2998 4120	2998 4120	2998 4120	2998 4180
3 / 4 pole	bottom	standard	standard	standard	standard	standard

Phase barrier shield

3 pole			2998 0003	2998 0003	2998 0003	2998 0003
4 pole			2998 0004	2998 0004	2998 0004	2998 0004

Handle key interlocking accessories

Locking using RONIS 1104 A lock ⁽¹⁾	front	3999 8104	3999 8104	3999 8104	3999 8104	3999 8104
Locking using RONIS EL11AP lock ⁽²⁾	direct front	3999 7007	3999 7007	3999 7007	3999 6117	3999 6117
Locking using RONIS EL11AP lock ⁽²⁾	external front	1499 7701	1499 7701	1499 7701	1499 7701	1499 7701

(1) Lock included.

(2) Lock not included.

SIDERMAT combination 630 to 1800 A

- Functions
- References
- ▶ Accessories
- Characteristics
- Dimensions

Accessories

Direct front operation handle

access_156_a_2_cat



References Rating (A)	Handle colour	References
630 ... 1800	Black	3999 6203
630 ... 1800	Red	consult us

Door interlocked external front operation

access_151_a_2_cat



access_166_a_2_cat



S3 handle

References Rating (A)	Handle type	Handle colour	External IP	References
630 ... 1800	S3	Black	IP55	1431 3511
630 ... 1800	S3	Red/Yellow	IP55	1432 3511

Alternative S-type handle cover colours

access_198_a_2_cat



Use
For single lever handles type S1, S2 and S3.
Other colours: please consult us.

References Handle colour	Pack qty	References
Light grey	50	1401 0001
Dark grey	50	1401 0011



Accessories

Shaft extension for external operation



access_144_0_1_coil

Use
For standard length external operation:
- 200 mm
- 320 mm.
Other lengths: please consult us.

References	Dimension X (mm)	Shaft length (mm)	References
Rating (A)			
630 ... 800	350 ... 450	200	1401 1520
630 ... 800	350 ... 570	320	1401 1532
1250 ... 1800	370 ... 570	320	1401 1532

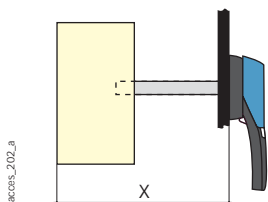

access_202_0

Alternative coils



access_049_0_1_coil

Shunt trip coil.



access_050_0_1_coil

Undervoltage trip coil.

Use
Omnipolar breaking remotely controlled by shunt trip or undervoltage voltage release coil.

NB: the shunt trip coil must not be supplied for more than 5 s. A shunt trip coil is fitted to the standard switch body. To modify this coil, the reference opposite must be added to the switch reference. Must be ordered at the same time as the switch.

Examples for ordering:

- SIDERMAT combination with shunt trip coil 230 VAC - 1 reference: SIDERMAT combination 630 A, 3 pole, padlockable direct front operation handle: 3520 **3063**.
- SIDERMAT combination fitted with a non standard coil - 2 references: SIDERMAT combination 630 A, 3 pole, padlockable direct front operation handle, fitted with a 110 VAC undervoltage trip coil: 3520 **3063** + 3991 **3110**.

References

Shunt trip coil

	Replacement tripping coil	Replacement of original coil
Voltage	References	References
24 VAC	3990 1024	3991 1024
48 VAC	3990 1048	3991 1048
110 VAC	3990 1110	3991 1110
230 VAC	3990 1220	standard
400 VAC	3990 1380	3991 1380
12 VDC	3990 2012	3991 2012
24 VDC	3990 2024	3991 2024
48 VDC	3990 2048	3991 2048
110 VDC	3990 2220	3991 2220
220 VDC	3990 2220	3991 2220

Undervoltage trip coil

	References	References
Voltage	References	References
24 VAC	3990 3024	3991 3024
48 VAC	3990 3048	3991 3048
110 VAC	3990 3110	3991 3110
230 VAC	3990 3220	3991 3220
400 VAC	3990 3380	3991 3380
12 VDC	3990 4012	3991 4012
24 VDC	3990 4024	3991 4024
48 VDC	3990 4048	3991 4048
110 VDC	3990 4110	3991 4110
220 VDC	3990 4220	3991 4220

Undervoltage delayed trip coil

	References
Voltage	References
230 VAC	3992 3230
400 VAC	3992 3400

Characteristics - see page A.90.

SIDERMAT combination 630 to 1800 A

- Functions
- References
- ▶ Accessories
- Characteristics
- Dimensions

Accessories

Current-reducing resistance for undervoltage release coil

Use

Reduces, by limiting the current, the effects on undervoltage release coils used in continuous processes or when they are exposed to high ambient temperatures.

References

Voltage	References
110 VAC	3999 3112
230 VAC	3999 3230
400 VAC	3999 3400
110 VDC	3999 4110

Auxiliary contacts

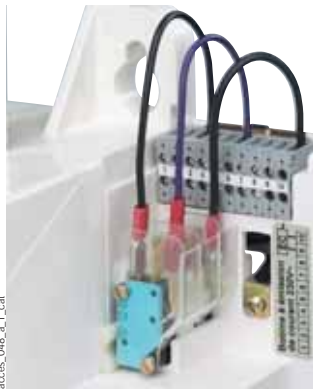

Use

Pre-breaking and signalling of positions 0 and I:
1 to 2 NO/NC auxiliary contacts.
Coil tripping:
1 to 2 NO/NC auxiliary contacts.

Connection to the control circuit

By fast-on terminal 6.35 mm.

Characteristics

NO/NC auxiliary contacts: IP2.

Electrical characteristics

30 000 operations.

References

NO/NC position contacts

Rating (A)	No. of AC	References
630 ... 1800	1 st	3999 0051
630 ... 1800	2 nd	3999 0052

NO/NC low level position contacts

Rating (A)	No. of AC	References
630 ... 1800	1 st	3999 0111
630 ... 1800	2 nd	3999 0112

NO/NC coil tripping contact

Rating (A)	No. of AC	Reference
630 ... 1800	1	3999 0031

Characteristics

NO/NC changeover position contacts

Rating (A)	Nominal current (A)	Operating current I _e (A)			
		250 VAC AC-13	400 VAC AC-13	24 VDC DC-13	48 VDC DC-13
630 ... 1800	16	12	8	14	6

NO/NC coil tripping contact

Rating (A)	Nominal current (A)	Operating current I _e (A)			
		250 VAC AC-13	400 VAC AC-13	24 VDC DC-13	48 VDC DC-13
630 ... 1800	16	12	8	12	2

Fuse blown indication

Use

For DIN fuse cartridge with striker.

Electrical principle

A NO/NC auxiliary contacts detects that the fuse has blown.

Connection to the control circuit

By fast-on terminal 6.35 mm.

Electrical characteristics

30 000 operations.

Reference

NO/NC changeover

Rating (A)	No. of poles	No. of AC	Reference
630 ... 1800	3 / 4	1 st AC	standard

NO/NC changeover position contact

Rating (A)	Nominal current (A)	Operating current I _e (A)			
		250 VAC AC-13	400 VAC AC-13	24 VDC DC-13	48 VDC DC-13
630 ... 1800	16	12	8	12	2



Accessories

Terminal shrouds

accs_212_a_2_cnl



Use

Top protection against direct contact with the terminals or connection parts.

Advantages

Holes allowing remote thermographic inspection without dismantling.

References

Rating (A)	No. of poles	Position	References
630	3	top	3998 3063
630	4	top	3998 4063

Terminal screens

accs_088_a_1_cnl



Use

Top or bottom protection against direct contacts with terminals or connection parts.

References

Rating (A)	No. of poles	Position	References
800 ... 1600	3	top	2998 3120
800 ... 1600	4	top	2998 4120
1800	3	top	2998 3180
1800	4	top	2998 4180
630 ... 1800	3 / 4	bottom	standard

Phase barrier shield

accs_036_a_1_cnl



Use

Safety isolation between the terminals, indispensable when using under 690 VAC or in a polluted atmosphere.

References

Rating (A)	No. of poles	References
1250 ... 1800	3	2998 0003
1250 ... 1800	4	2998 0004

Handle key interlocking accessories

Use

Locking in position 0 of front operation:

- using padlock (not supplied) and factory integrated into the handle. Padlocking, for external front operation, locks the door
- using RONIS 1104A lock (key BC 3318) to be mounted directly on the padlockable handle
- using RONIS EL11AP lock (not included) according to the opposite table.

References

Locking using RONIS 1104A lock (included)

Rating (A)	Operation	Reference
630 ... 1800	front	3999 8104

Locking using RONIS EL11AP lock (not included)

Rating (A)	Operation	References
630 ... 1250	direct	3999 7007
1600 ... 1800	direct	3999 6117
630 ... 1800	external front	1499 7701

Other specific accessories

bd_01_01_03



- Specific shields (dimensions, or for high ambient temperatures)
- Connection accessories
- Mounting plates for standard systems
- Special construction available for specific environments.

SIDERMAT combination 630 to 1800 A

Functions

References

Accessories

▶ Characteristics

▶ Dimensions

Characteristics (according to IEC 60947-3)

Thermal current I_{th} (40°C)	630 A	800 A	1250 A	1600 A	1800 A
Fuse size	3	4	4	2 x 4	2 x 4
Rated insulation voltage U_i (V)	1000	1000	1000	1000	1000
Rated impulse withstand voltage U_{imp} (kV)	12	12	12	12	12

Rated operational currents I_e (A)

Rated voltage	Load duty category	A/B ⁽¹⁾	A/B ⁽¹⁾	A/B ⁽¹⁾	A/B ⁽¹⁾	A/B ⁽¹⁾
400 VAC	AC-22 A / AC-22 B	630/630	800/800	1250/1250	1600/1600	1600/1800
	AC-23 A / AC-23 B	630/630	630/630	1250/1250	1600/1600	1600/1600
690 VAC ⁽²⁾	AC-21 A / AC-21 B	630/630	800/800	1250/1250	1600/1600	
	AC-22 A / AC-22 B	500/630	630/800	1000/1000	1250/1250	
	AC-23 A / AC-23 B	400/500	500/500	800/800	1000/1000	
220 VDC	DC-21 A / DC-21 B	630/630	800/800	1250/1250	1600/1600	-/-
	DC-22 A / DC-22 B	630/630	800/800	1250/1250	1600/1600	-/-
	DC-23 A / DC-23 B	500/630	630/800	1250/1250	1250/1250	-/-
440 VDC	DC-20 A / DC-20 B	630/630	800/800	1250/1250	1600/1600	-/-
	DC-21 A / DC-21 B	630/630	800/800	1250/1250	1600/1600	-/-
	DC-22 A / DC-22 B	630/630 ⁽³⁾	800/800 ⁽³⁾	1250/1250 ⁽⁴⁾	1600/1600 ⁽⁴⁾	-/-
	DC-23 A / DC-23 B	500/630 ⁽³⁾	630/800 ⁽³⁾	1250/1250 ⁽⁴⁾	1250/1250 ⁽⁴⁾	-/-

Operational power (kW)⁽¹⁾⁽⁵⁾

At 400 VAC without pre-break AC in AC-23	355/355	355/355	710/710	900/900	900/900
At 690 VAC without pre-break AC in AC-23	400/475	475/475	750/750	900/900	-
At 400 VAC without pre-break AC	355/355	450/450	710/710	900/900	900/900
At 690 VAC without pre-break AC	475/600	600/750	900/900	1100/1100	-

Reactive power (kvar)⁽⁵⁾

At 400 VAC	290	365	575	-	-
------------	-----	-----	-----	---	---

Fuse protected short-circuit withstand (kA rms prospective)⁽⁶⁾

Prospective short-circuit current (kA rms)	100	100	100	120	120
Associated fuse rating (A)	630	800	1250	2 x 800	2 x 900

Overload capacity⁽⁶⁾

Rated peak withstand current (kA peak)	55	80	100	120	120
--	----	----	-----	-----	-----

Connection

Minimum Cu cable section (mm ²)	2 x 150	2 x 185			4 x 240
Minimum Cu busbar section (mm ²)	2 x 30 x 5	2 x 40 x 5	2 x 60 x 5	2 x 80 x 5	-
Maximum Cu cable section (mm ²)	2 x 300	2 x 300	4 x 185	6 x 240	8 x 240
Maximum Cu busbar width (mm)	50	63	100	100	100
Min. tightening torque (Nm)		20	20	40	-

Mechanical characteristics

Endurance (number of operating cycles)	5000	5000	5000	3000	3000
Weight of 3 p switch (kg)	20	25	27	54	59
Weight of 4 p switch (kg)	24	30	32	70	75

(1) A/B: Category with index A = frequent operation - Category with index B = infrequent operation.

(2) With terminal shrouds or phase barrier.

(3) Poles cannot be juxtaposed.

(4) 4-pole device with 2 pole in series by polarity.

(5) The power value is given for information only, the current values vary from one manufacturer to another.

(6) For a rated operating voltage $U_e = 400$ VAC.



Dimensions

• SIDERMAT combination 630 A

Direct front operation

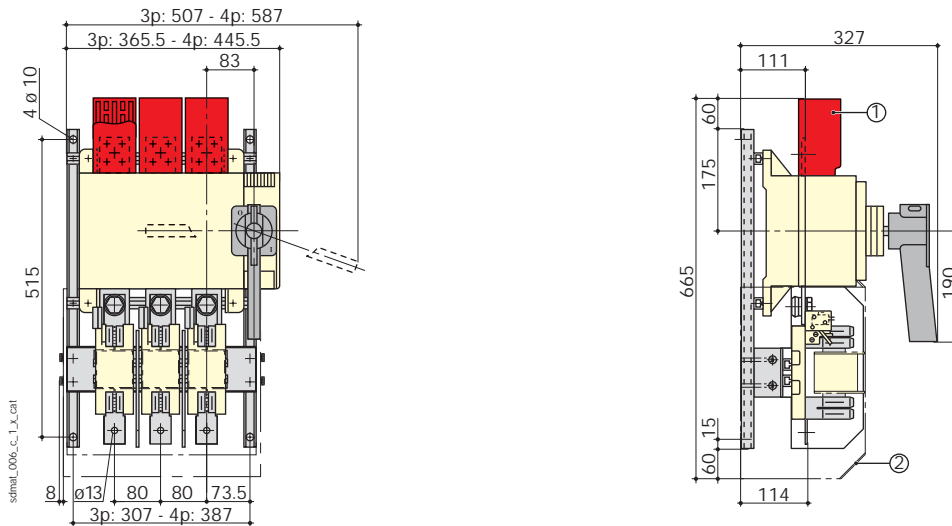

1. Terminal shrouds
2. Terminal screens.

• SIDERMAT combination 800 to 1250 A

Direct front operation

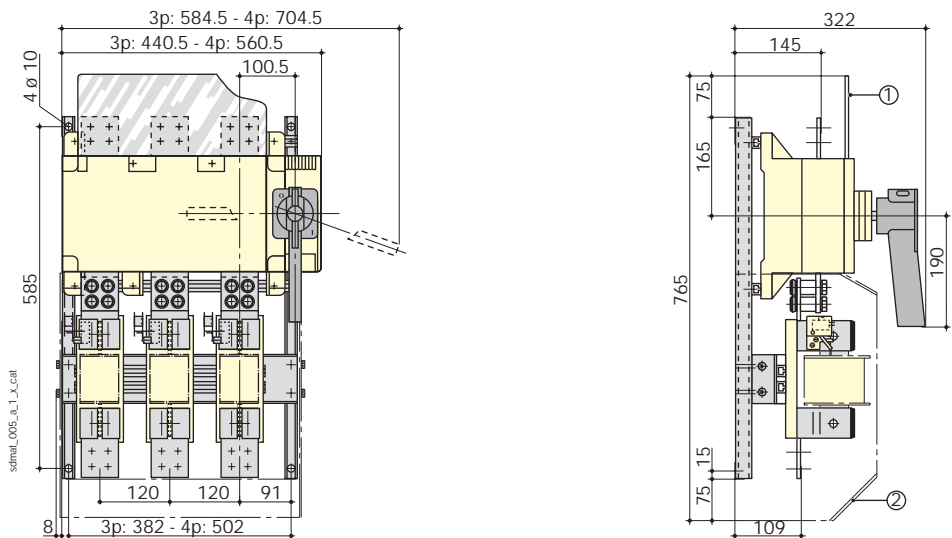

1. Top terminal screens.
2. Bottom terminal screens.

SIDERMAT combination 630 to 1800 A

Dimensions

• SIDERMAT combination 1600 A

Direct front operation

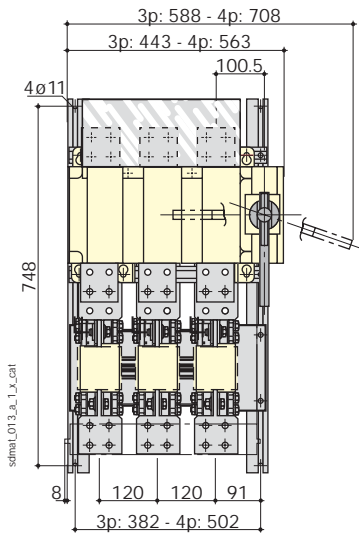

1. Top terminal screens.
2. Bottom terminal screens.

• SIDERMAT combination 1800 A

Direct front operation

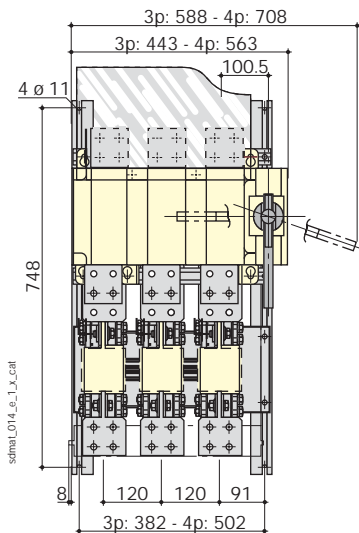

1. Top terminal screens.
2. Bottom terminal screens.



Dimensions

► Connection terminals

- SIDERMAT combination 630 A

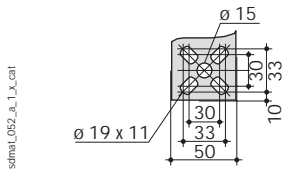

- SIDERMAT combination 800 to 1250 A

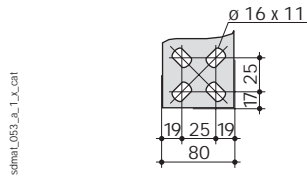

- SIDERMAT combination 1600 to 1800 A - bottom

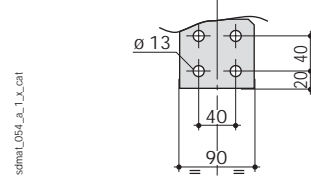

- SIDERMAT combination 1600 - top

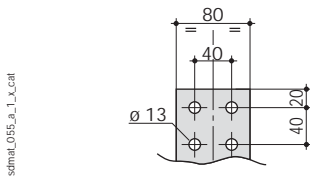

- SIDERMAT combination 1800 A - top

